

The New Symbol of the High Density Mating Age

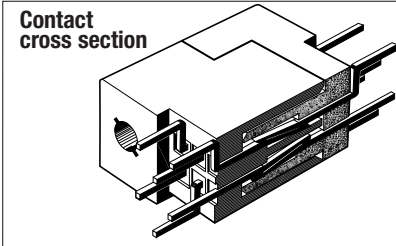

Contacts with 2 mating points straight-beam construction (Patented)

The KEL patented Hi-PACKEL™ contact design features 2 mating points and straight-beam construction, which offers low insertion force and high reliability.

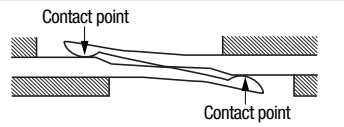

This ingenious design creates a long wiping action for both contacts upon insertion, 2 separate contact points for excellent continuity and straight-beam construction resulting in excellent reliability.

■ Variation (KEL offers 4 configurations to address varying design needs)

With flanges (Without hooks) 8800 / 8810 series	With flanges (With hooks) 8801 / 8811 series	Without flanges 8802 / 8812 series	With power contacts 8803 / 8813 series
<p>● Flanges (without hooks) has holes for screw mounting.</p>	<p>● Flanges (with hooks) prevents the connector from "floating" during the dip solder process.</p>	<p>● Without flanges to save space.</p>	<p>● With power contacts in cases where it is desired that power and signals be separated.</p>

Hi-PACKEL Family of connectors offer superior reliability in a "half-pitch" connector system, using the KEL patented Hi-PACKEL™ "2 mating points straight-beam construction"

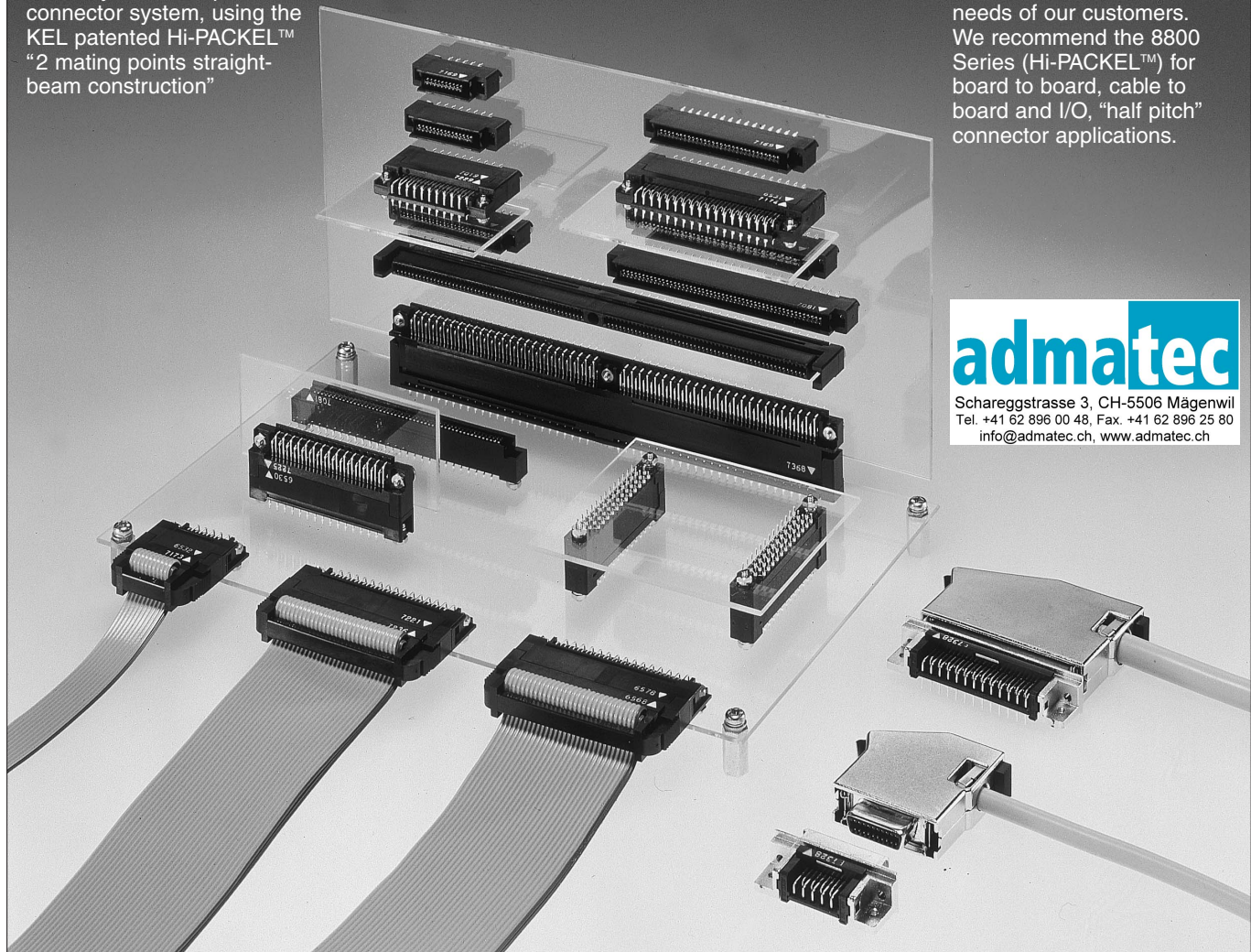

KEL offers abundant variations and many series to address the various needs of our customers. We recommend the 8800 Series (Hi-PACKEL™) for board to board, cable to board, and I/O, "half pitch" connector applications.



Schareggstrasse 3, CH-5506 Mägenwil
Tel. +41 62 896 00 48, Fax. +41 62 896 25 80
info@admatec.ch, www.admatec.ch

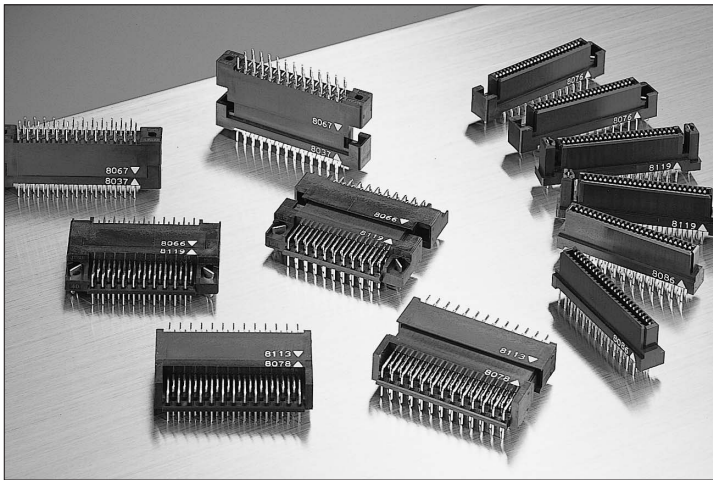

FEATURES

- Patented Hi-PACKEL™ contact design features 2 mating points per connection
- Low insertion and withdrawal force
- Plug and Receptacle contacts share common tooling which means increased productivity and greater product diversity
- Insulator designed to prevent mis-insertion and protect the contacts from damage
- Power (Ground) contacts are first mate and last break
- RoHS compliance

SPECIFICATIONS

- Insulator : Glass-filled Nylon 66 (UL 94V-0), Black
- Contact : Phosphor Bronze
- Plating : [Signal contact]
 - Contact area ; Gold over Nickel
 - (1) Standard : 0.05μm min. Gold
 - (2) Upon request : 0.25μm min. Gold
- [Power contact] (8803/8813 series) ;Gold over Nickel
 - (1) Standard : 0.05μm min. Gold
 - (2) Upon request : 0.25μm min. Gold
- Current rating : Signal contact ; 0.5A per contact
 - Power contact (8803/8813 Series) ; 2A per contact
- Contact resistance : 25mΩ max.
- Withstanding voltage : 650V AC for 1 minute
- Insulation resistance : 1,000MΩ min. at 500V DC
- Operating temperature : -55°C to +85°C
- Insulation force (Typical example) :
 - 1.9kg max. / 20 pin, 3.8kg max. / 40 pin
 - 5.7kg max. / 60 pin, 9.5kg max. / 100pin
- Withdrawal force (Typical example) :
 - 0.3kg min. / 20 pin, 0.8kg min. / 40 pin
 - 1.2kg min. / 60 pin, 2.0kg min. / 100 pin

ORDER CODE

88 - - - - **-170** - - - - **-F**

- **F** : RoHS Compliance
- Plating of contact area
 - Omit : Au 0.05μm (Standard)
 - D : Au 0.25μm
- Contact tail style
 - L : Right angle
 - S : Straight
- Contact name
 - 170
- Number of contacts

020 : 20 pin	026 : 26 pin
030 : 30 pin	032 : 32 pin
034 : 34 pin	040 : 40 pin
050 : 50 pin	052 : 52 pin
060 : 60 pin	068 : 68 pin
080 : 80 pin	100 : 100 pin
- Series name
- Receptacle
 - 8800 : With flanges and without hooks
 - 8801 : With flanges and hooks
 - 8802 : Without flanges
 - 8803 : With power contacts
- Plug
 - 8810 : With flanges and without hooks
 - 8811 : With flanges and hooks
 - 8812 : Without flanges
 - 8813 : With power contacts

MATING VARIATIONS

Unit:mm(inch)

Horizontal, Vertical and Stacked mating options available as illustrated.

Horizontal Mating

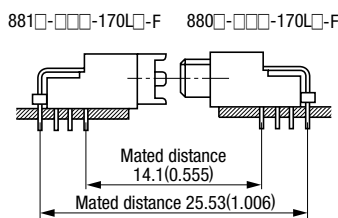

Vertical Mating

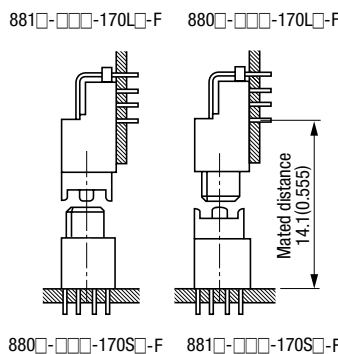

Stacked Mating

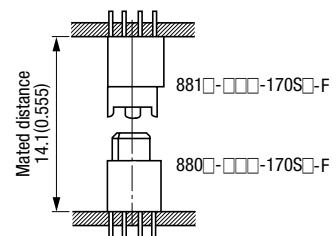

8800-□□□-170S□-F (Receptacle, With Flanges) / 8801-□□□-170S□-F (Receptacle, With hooks)

Unit:mm(inch)

Receptacle (Straight Type)

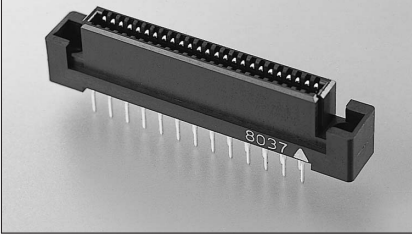
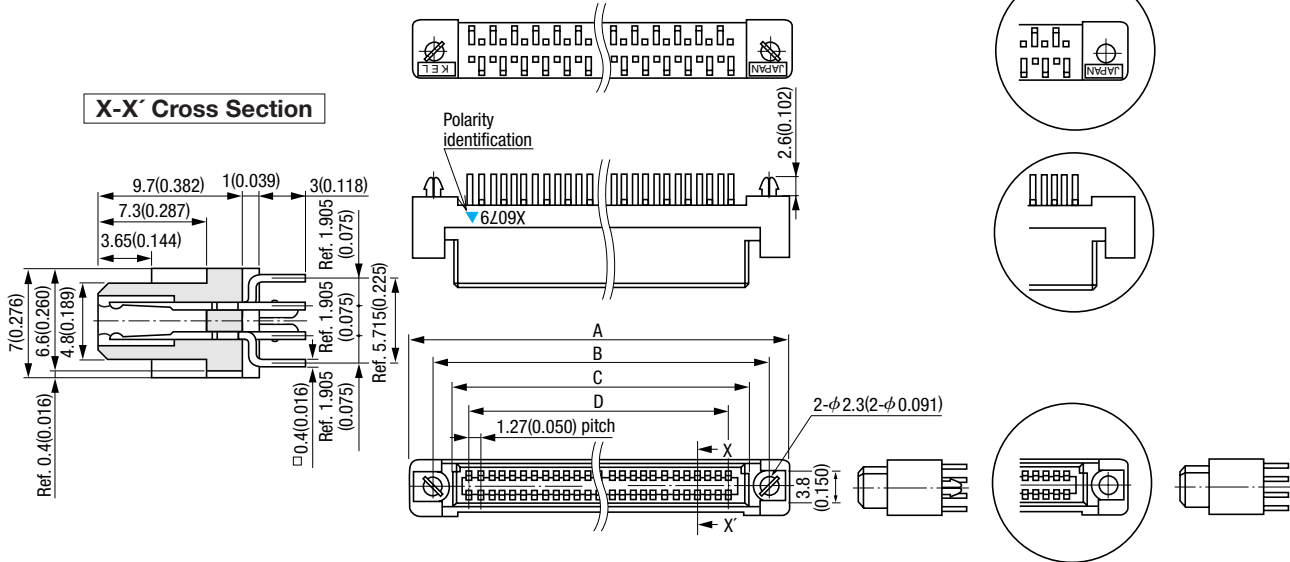
8801-□□□-170S□-F
8800-□□□-170S□-F
X-X' Cross Section

Printed Circuit Board Layout (Component Side View)

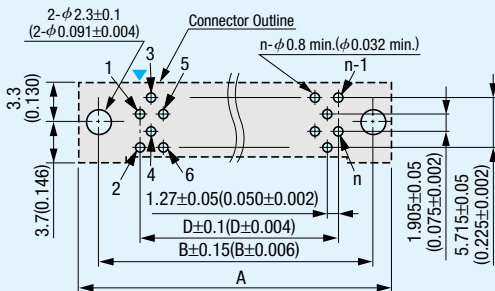
For 20,32,40,52,60,68,80,100 contacts

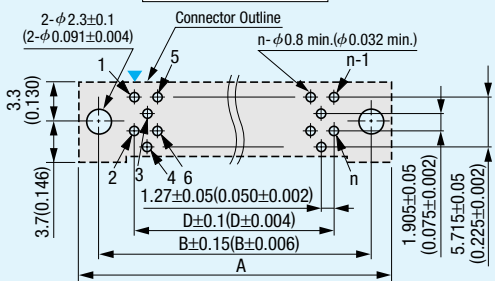

For 26,30,34,50 contacts



▼=Polarity identification
 Recommended PCB Thickness t=1.6±0.19(0.063±0.007)
 "n" is number of contacts.

Product Table / Dimensions

No. of contacts	Part Number	A	B	C	D
20	8800-020-170S□-F	25.43	20.32	15.43	11.43
	8801-020-170S□-F	(1.001)	(0.800)	(0.608)	(0.450)
26	8800-026-170S□-F	29.24	24.13	19.24	15.24
	8801-026-170S□-F	(1.151)	(0.950)	(0.758)	(0.600)
30	8800-030-170S□-F	31.78	26.67	21.78	17.78
	8801-030-170S□-F	(1.251)	(1.050)	(0.858)	(0.700)
32	8800-032-170S□-F	33.05	27.94	23.05	19.05
	8801-032-170S□-F	(1.301)	(1.100)	(0.908)	(0.750)
34	8800-034-170S□-F	34.32	29.21	24.32	20.32
	8801-034-170S□-F	(1.351)	(1.150)	(0.958)	(0.800)
40	8800-040-170S□-F	38.13	33.02	28.13	24.13
	8801-040-170S□-F	(1.501)	(1.300)	(1.108)	(0.950)
50	8800-050-170S□-F	44.48	39.37	34.48	30.48
	8801-050-170S□-F	(1.751)	(1.550)	(1.358)	(1.200)
52	8800-052-170S□-F	45.75	40.64	35.75	31.75
	8801-052-170S□-F	(1.801)	(1.600)	(1.408)	(1.250)
60	8800-060-170S□-F	50.83	45.72	40.83	36.83
	8801-060-170S□-F	(2.001)	(1.800)	(1.608)	(1.450)
68	8800-068-170S□-F	55.91	50.80	45.91	41.91
	8801-068-170S□-F	(2.201)	(2.000)	(1.808)	(1.650)
80	8800-080-170S□-F	63.53	58.42	53.53	49.53
	8801-080-170S□-F	(2.501)	(2.300)	(2.108)	(1.950)
100	8800-100-170S□-F	76.23	71.12	66.23	62.23
	8801-100-170S□-F	(3.001)	(2.800)	(2.608)	(2.450)

8802-□□□-170S□-F (Receptacle, Without Flanges)

Unit:mm(inch)

Receptacle (Straight Type)

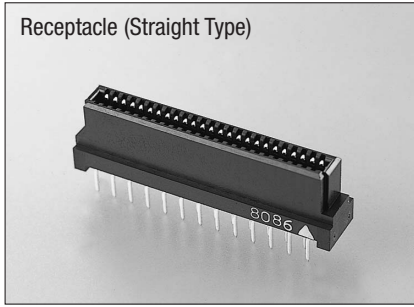

X-X' Cross Section

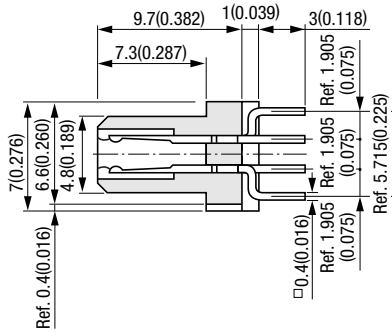

Polarity identification

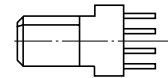
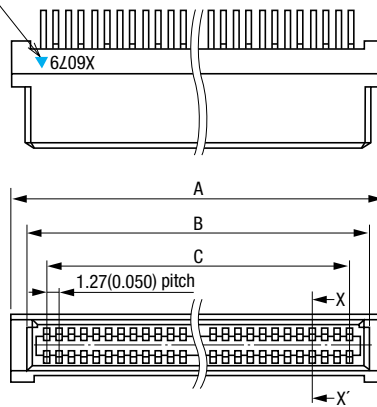

Printed Circuit Board Layout (Component Side View)

For 20,32,40,52,60,68,80,100 contacts

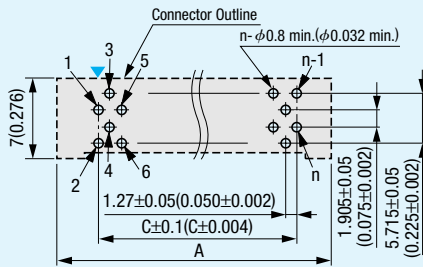

For 26,30,34,50 contacts

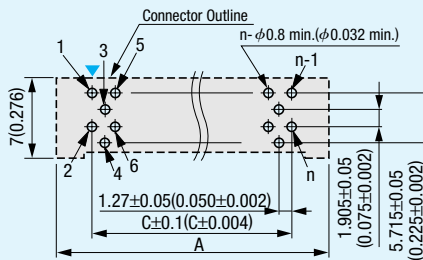

▼=Polarity identification
Recommended PCB Thickness t=1.6 ± 0.19 (0.063 ± 0.007)
"n" is number of contacts.

Product Table / Dimensions

No. of contacts	Part Number	A	B	C
20	8802-020-170S□-F	17.83 (0.702)	15.43 (0.608)	11.43 (0.450)
26	8802-026-170S□-F	21.64 (0.852)	19.24 (0.758)	15.24 (0.600)
30	8802-030-170S□-F	24.18 (0.952)	21.78 (0.858)	17.78 (0.700)
32	8802-032-170S□-F	25.45 (1.002)	23.05 (0.908)	19.05 (0.750)
34	8802-034-170S□-F	26.72 (1.052)	24.32 (0.958)	20.32 (0.800)
40	8802-040-170S□-F	30.53 (1.202)	28.13 (1.108)	24.13 (0.950)
50	8802-050-170S□-F	36.88 (1.452)	34.48 (1.358)	30.48 (1.200)
52	8802-052-170S□-F	38.15 (1.502)	35.75 (1.408)	31.75 (1.250)
60	8802-060-170S□-F	43.23 (1.702)	40.83 (1.608)	36.83 (1.450)
68	8802-068-170S□-F	48.31 (1.902)	45.91 (1.808)	41.91 (1.650)
80	8802-080-170S□-F	55.93 (2.202)	53.53 (2.108)	49.53 (1.950)
100	8802-100-170S□-F	68.63 (2.702)	66.23 (2.608)	62.23 (2.450)

8800-□□□-170L□-F (Receptacle, With Flanges) / 8801-□□□-170L□-F (Receptacle, With hooks)

Unit:mm(inch)

Receptacle (Right Angle Type)

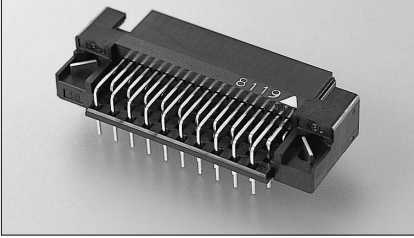
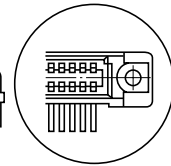
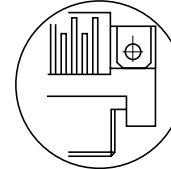
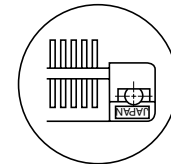
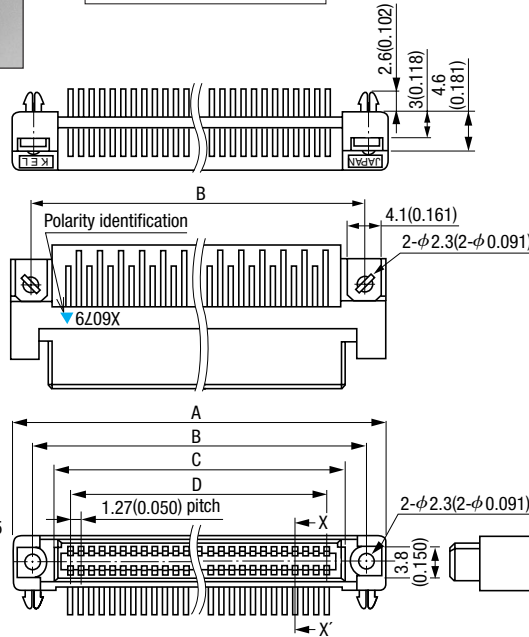
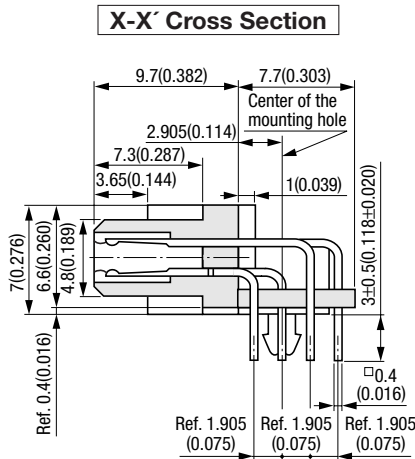
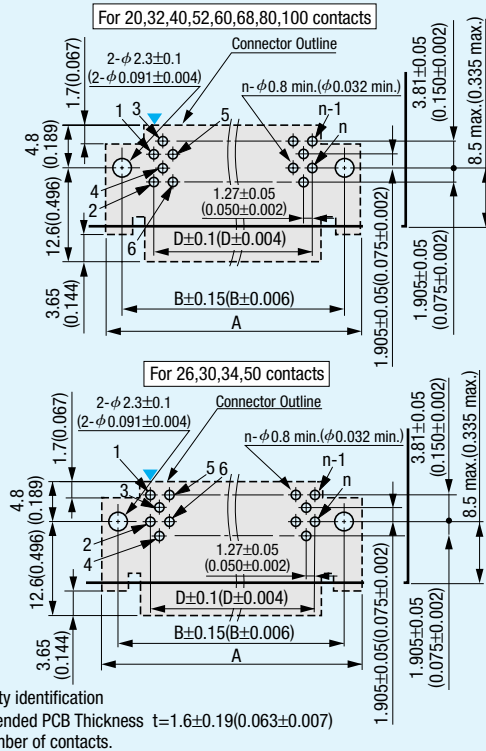

8801-□□□-170L□-F
8800-□□□-170L□-F

Printed Circuit Board Layout (Component Side View)

Product Table / Dimensions

No. of contacts	Part Number	A	B	C	D
20	8800-020-170L□-F	25.43	20.32	15.43	11.43
	8801-020-170L□-F	(1.001)	(0.800)	(0.608)	(0.450)
26	8800-026-170L□-F	29.24	24.13	19.24	15.24
	8801-026-170L□-F	(1.151)	(0.950)	(0.758)	(0.600)
30	8800-030-170L□-F	31.78	26.67	21.78	17.78
	8801-030-170L□-F	(1.251)	(1.050)	(0.858)	(0.700)
32	8800-032-170L□-F	33.05	27.94	23.05	19.05
	8801-032-170L□-F	(1.301)	(1.100)	(0.908)	(0.750)
34	8800-034-170L□-F	34.32	29.21	24.32	20.32
	8801-034-170L□-F	(1.351)	(1.150)	(0.958)	(0.800)
40	8800-040-170L□-F	38.13	33.02	28.13	24.13
	8801-040-170L□-F	(1.501)	(1.300)	(1.108)	(0.950)
50	8800-050-170L□-F	44.48	39.37	34.48	30.48
	8801-050-170L□-F	(1.751)	(1.550)	(1.358)	(1.200)
52	8800-052-170L□-F	45.75	40.64	35.75	31.75
	8801-052-170L□-F	(1.801)	(1.600)	(1.408)	(1.250)
60	8800-060-170L□-F	50.83	45.72	40.83	36.83
	8801-060-170L□-F	(2.001)	(1.800)	(1.608)	(1.450)
68	8800-068-170L□-F	55.91	50.80	45.91	41.91
	8801-068-170L□-F	(2.201)	(2.000)	(1.808)	(1.650)
80	8800-080-170L□-F	63.53	58.42	53.53	49.53
	8801-080-170L□-F	(2.501)	(2.300)	(2.108)	(1.950)
100	8800-100-170L□-F	76.23	71.12	66.23	62.23
	8801-100-170L□-F	(3.001)	(2.800)	(2.608)	(2.450)

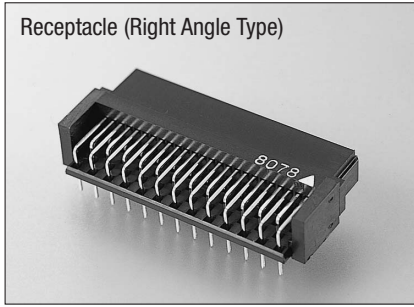
8802-□□□-170L□-F (Receptacle, Without Flanges)

Unit:mm(inch)

Receptacle (Right Angle Type)



X-X' Cross Section

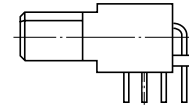
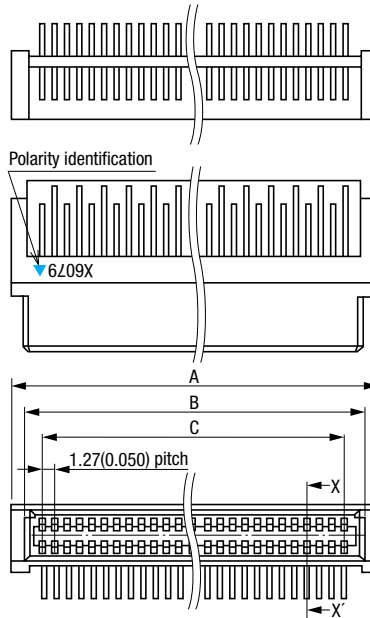
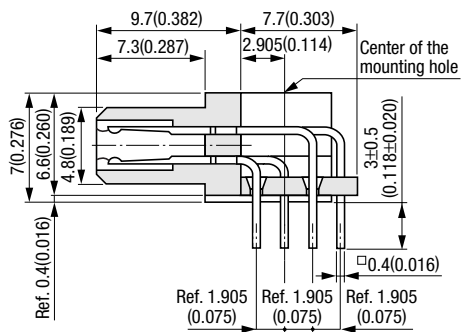

Printed Circuit Board Layout (Component Side View)

For 20,32,40,52,60,68,80,100 contacts

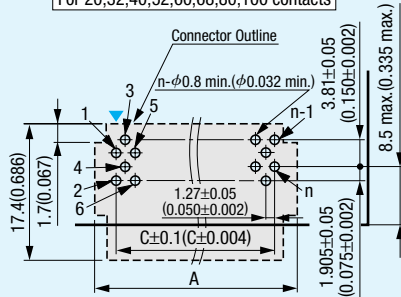

For 26,30,34,50 contacts

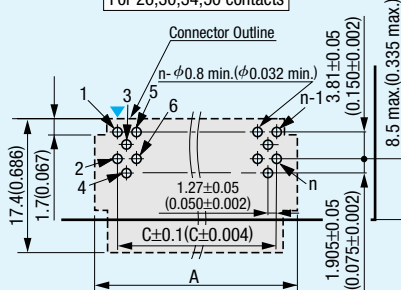

▼=Polarity identification
 Recommended PCB Thickness t=1.6±0.19(0.063±0.007)
 "n" is number of contacts.

Product Table / Dimensions

No. of contacts	Part Number	A	B	C
20	8802-020-170L□-F	17.83 (0.702)	15.43 (0.608)	11.43 (0.450)
26	8802-026-170L□-F	21.64 (0.852)	19.24 (0.758)	15.24 (0.600)
30	8802-030-170L□-F	24.18 (0.952)	21.78 (0.858)	17.78 (0.700)
32	8802-032-170L□-F	25.45 (1.002)	23.05 (0.908)	19.05 (0.750)
34	8802-034-170L□-F	26.72 (1.052)	24.32 (0.958)	20.32 (0.800)
40	8802-040-170L□-F	30.53 (1.202)	28.13 (1.108)	24.13 (0.950)
50	8802-050-170L□-F	36.88 (1.452)	34.48 (1.358)	30.48 (1.200)
52	8802-052-170L□-F	38.15 (1.502)	35.75 (1.408)	31.75 (1.250)
60	8802-060-170L□-F	43.23 (1.702)	40.83 (1.608)	36.83 (1.450)
68	8802-068-170L□-F	48.31 (1.902)	45.91 (1.808)	41.91 (1.650)
80	8802-080-170L□-F	55.93 (2.202)	53.53 (2.108)	49.53 (1.950)
100	8802-100-170L□-F	68.63 (2.702)	66.23 (2.608)	62.23 (2.450)

8810-□□□-170S□-F (Plug, With Flanges) / 8811-□□□-170S□-F (Plug, With hooks)

Unit:mm(inch)

Plug (Straight Type)

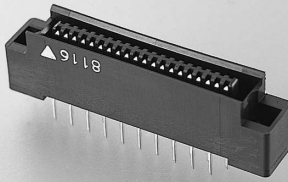
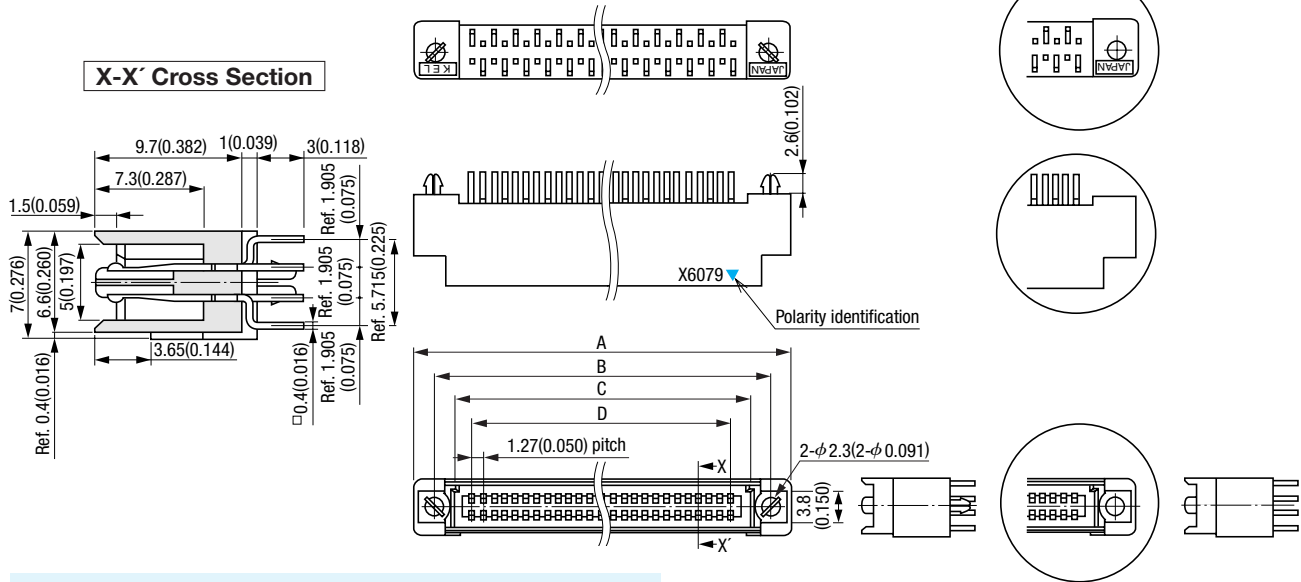
8811-□□□-170S□-F
8810-□□□-170S□-F
X-X' Cross Section

Printed Circuit Board Layout (Component Side View)

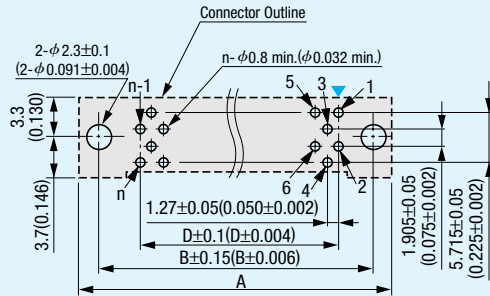
For 20,32,40,52,60,68,80,100 contacts

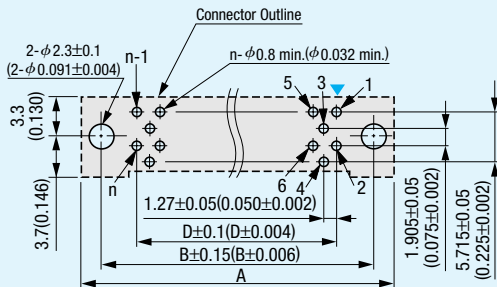

For 26,30,34,50 contacts

 ▼=Polarity identification
 Recommended PCB Thickness $t=1.6\pm 0.19(0.063\pm 0.007)$
 "n" is number of contacts.

Product Table / Dimensions

No. of contacts	Part Number	A	B	C	D
20	8810-020-170S□-F	25.43	20.32	15.83	11.43
	8811-020-170S□-F	(1.001)	(0.800)	(0.623)	(0.450)
26	8810-026-170S□-F	29.24	24.13	19.64	15.24
	8811-026-170S□-F	(1.151)	(0.950)	(0.773)	(0.600)
30	8810-030-170S□-F	31.78	26.67	22.18	17.78
	8811-030-170S□-F	(1.251)	(1.050)	(0.873)	(0.700)
32	8810-032-170S□-F	33.05	27.94	23.45	19.05
	8811-032-170S□-F	(1.301)	(1.100)	(0.923)	(0.750)
34	8810-034-170S□-F	34.32	29.21	24.72	20.32
	8811-034-170S□-F	(1.351)	(1.150)	(0.973)	(0.800)
40	8810-040-170S□-F	38.13	33.02	28.53	24.13
	8811-040-170S□-F	(1.501)	(1.300)	(1.123)	(0.950)
50	8810-050-170S□-F	44.48	39.37	34.88	30.48
	8811-050-170S□-F	(1.751)	(1.550)	(1.373)	(1.200)
52	8810-052-170S□-F	45.75	40.64	36.15	31.75
	8811-052-170S□-F	(1.801)	(1.600)	(1.423)	(1.250)
60	8810-060-170S□-F	50.83	45.72	41.23	36.83
	8811-060-170S□-F	(2.001)	(1.800)	(1.623)	(1.450)
68	8810-068-170S□-F	55.91	50.80	46.31	41.91
	8811-068-170S□-F	(2.201)	(2.000)	(1.823)	(1.650)
80	8810-080-170S□-F	63.53	58.42	53.93	49.53
	8811-080-170S□-F	(2.501)	(2.300)	(2.123)	(1.950)
100	8810-100-170S□-F	76.23	71.12	66.63	62.23
	8811-100-170S□-F	(3.001)	(2.800)	(2.623)	(2.450)

8812-□□□□-170S□-F (Plug, Without Flanges)

Unit:mm(inch)

Plug (Straight Type)

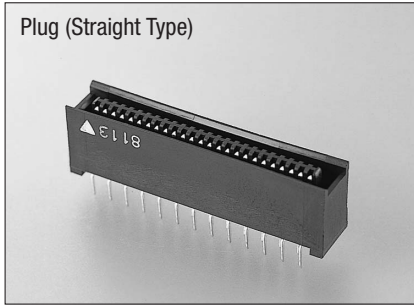

X-X' Cross Section

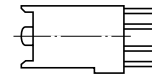
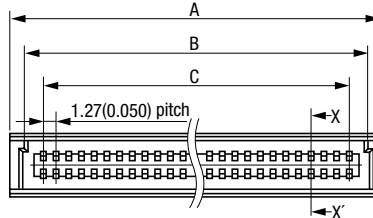
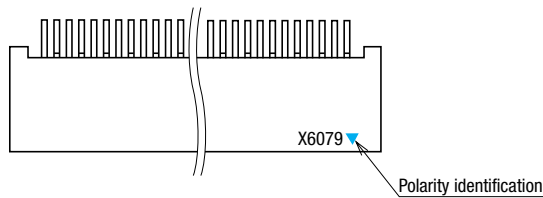
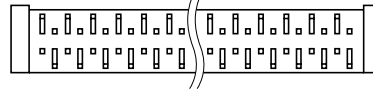
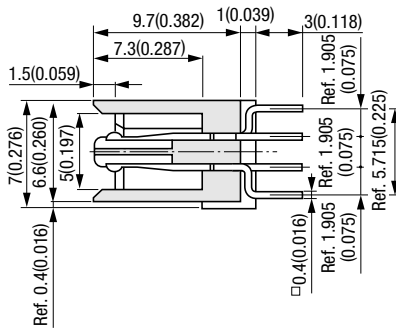

Printed Circuit Board Layout (Component Side View)

For 20,32,40,52,60,68,80,100 contacts

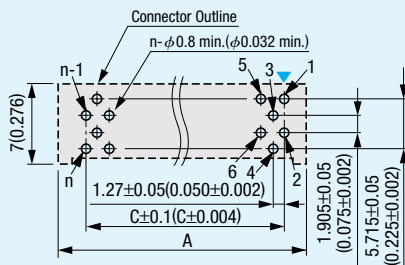

For 26,30,34,50 contacts

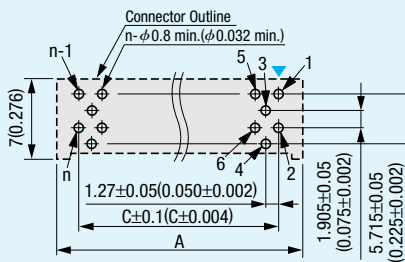

▼=Polarity identification
Recommended PCB Thickness t=1.6±0.19(0.063±0.007)
"n" is number of contacts.

Product Table / Dimensions

No. of contacts	Part Number	A	B	C
20	8812-020-170S□-F	17.83 (0.702)	15.83 (0.623)	11.43 (0.450)
26	8812-026-170S□-F	21.64 (0.852)	19.64 (0.773)	15.24 (0.600)
30	8812-030-170S□-F	24.18 (0.952)	22.18 (0.873)	17.78 (0.700)
32	8812-032-170S□-F	25.45 (1.002)	23.45 (0.923)	19.05 (0.750)
34	8812-034-170S□-F	26.72 (1.052)	24.72 (0.973)	20.32 (0.800)
40	8812-040-170S□-F	30.53 (1.202)	28.53 (1.123)	24.13 (0.950)
50	8812-050-170S□-F	36.88 (1.452)	34.88 (1.373)	30.48 (1.200)
52	8812-052-170S□-F	38.15 (1.502)	36.15 (1.423)	31.75 (1.250)
60	8812-060-170S□-F	43.23 (1.702)	41.23 (1.623)	36.83 (1.450)
68	8812-068-170S□-F	48.31 (1.902)	46.31 (1.823)	41.91 (1.650)
80	8812-080-170S□-F	55.93 (2.202)	53.93 (2.123)	49.53 (1.950)
100	8812-100-170S□-F	68.63 (2.702)	66.63 (2.623)	62.23 (2.450)

8810-□□□-170L□-F (Plug, With Flanges) / 8811-□□□-170L□-F (Plug, With hooks)

Unit:mm(inch)

Plug (Right Angle Type)

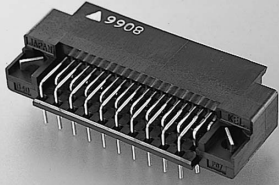
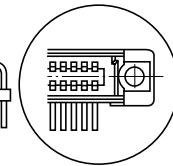
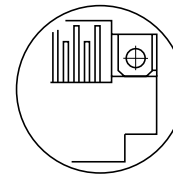
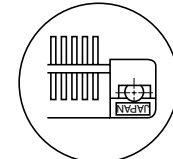
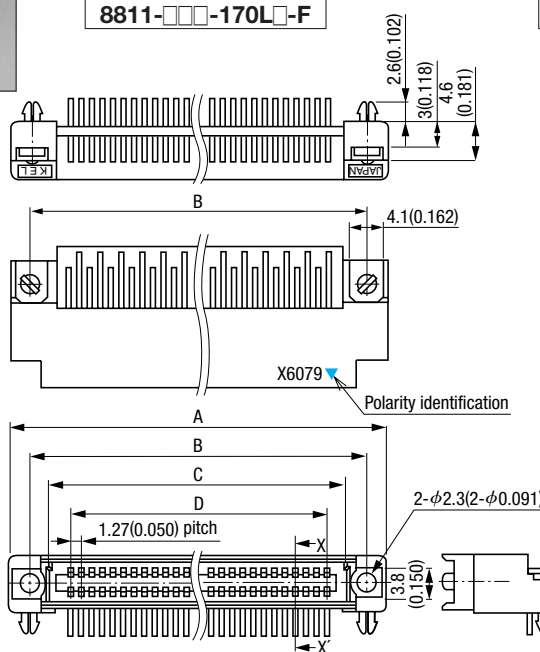
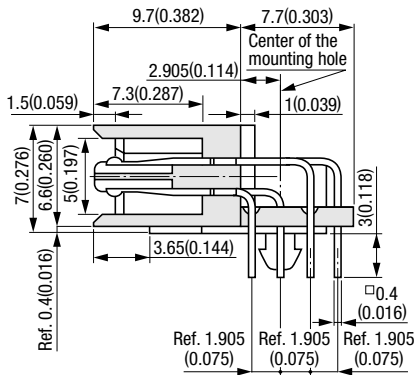
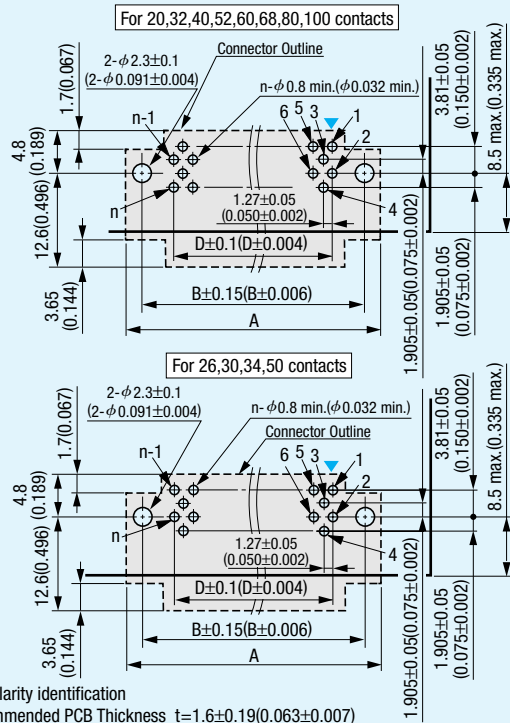
8811-□□□-170L□-F
8810-□□□-170L□-F
X-X' Cross Section

Printed Circuit Board Layout (Component Side View)

▼=Polarity identification
 Recommended PCB Thickness t=1.6±0.19(0.063±0.007)
 "n" is number of contacts.

Product Table / Dimensions

No. of contacts	Part Number	A	B	C	D
20	8810-020-170L□-F	25.43	20.32	15.83	11.43
	8811-020-170L□-F	(1.001)	(0.800)	(0.623)	(0.450)
26	8810-026-170L□-F	29.24	24.13	19.64	15.24
	8811-026-170L□-F	(1.151)	(0.950)	(0.773)	(0.600)
30	8810-030-170L□-F	31.78	26.67	22.18	17.78
	8811-030-170L□-F	(1.251)	(1.050)	(0.873)	(0.700)
32	8810-032-170L□-F	33.05	27.94	23.45	19.05
	8811-032-170L□-F	(1.301)	(1.100)	(0.923)	(0.750)
34	8810-034-170L□-F	34.32	29.21	24.72	20.32
	8811-034-170L□-F	(1.351)	(1.150)	(0.973)	(0.800)
40	8810-040-170L□-F	38.13	33.02	28.53	24.13
	8811-040-170L□-F	(1.501)	(1.300)	(1.123)	(0.950)
50	8810-050-170L□-F	44.48	39.37	34.88	30.48
	8811-050-170L□-F	(1.751)	(1.550)	(1.373)	(1.200)
52	8810-052-170L□-F	45.75	40.64	36.15	31.75
	8811-052-170L□-F	(1.801)	(1.600)	(1.423)	(1.250)
60	8810-060-170L□-F	50.83	45.72	41.23	36.83
	8811-060-170L□-F	(2.001)	(1.800)	(1.623)	(1.450)
68	8810-068-170L□-F	55.91	50.80	46.31	41.91
	8811-068-170L□-F	(2.201)	(2.000)	(1.823)	(1.650)
80	8810-080-170L□-F	63.53	58.42	53.93	49.53
	8811-080-170L□-F	(2.501)	(2.300)	(2.123)	(1.950)
100	8810-100-170L□-F	76.23	71.12	66.63	62.23
	8811-100-170L□-F	(3.001)	(2.800)	(2.623)	(2.450)

8812-□□□-170L□-F (Plug, Without Flanges)

Unit:mm(inch)

Plug (Right Angle Type)

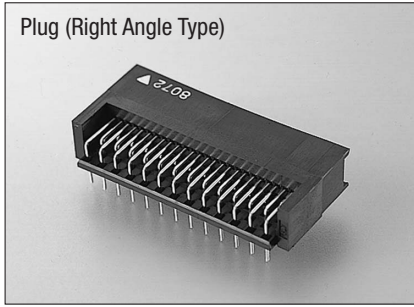

X-X' Cross Section

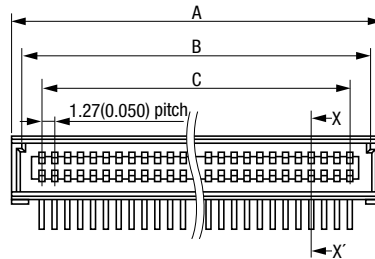
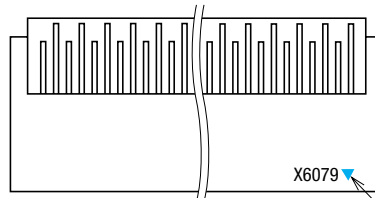
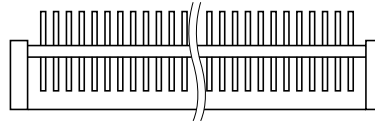
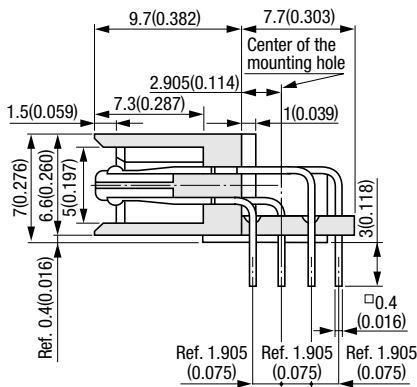

X6079 Polarity identification

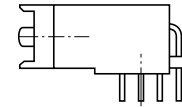

Printed Circuit Board Layout (Component Side View)

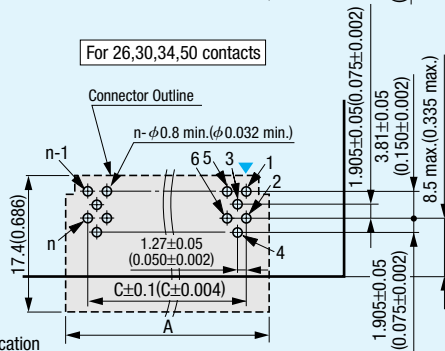
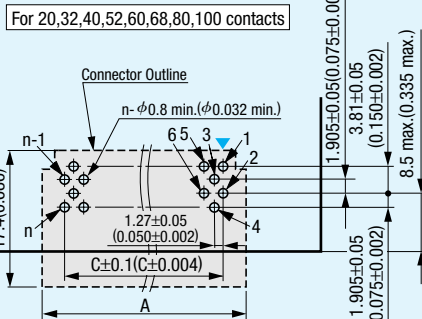

▼=Polarity identification
Recommended PCB Thickness t=1.6±0.19(0.063±0.007)
"n" is number of contacts.

Product Table / Dimensions

No. of contacts	Part Number	A	B	C
20	8812-020-170L□-F	17.83 (0.702)	15.83 (0.623)	11.43 (0.450)
26	8812-026-170L□-F	21.64 (0.852)	19.64 (0.773)	15.24 (0.600)
30	8812-030-170L□-F	24.18 (0.952)	22.18 (0.873)	17.78 (0.700)
32	8812-032-170L□-F	25.45 (1.002)	23.45 (0.923)	19.05 (0.750)
34	8812-034-170L□-F	26.72 (1.052)	24.72 (0.973)	20.32 (0.800)
40	8812-040-170L□-F	30.53 (1.202)	28.53 (1.123)	24.13 (0.950)
50	8812-050-170L□-F	36.88 (1.452)	34.88 (1.373)	30.48 (1.200)
52	8812-052-170L□-F	38.15 (1.502)	36.15 (1.423)	31.75 (1.250)
60	8812-060-170L□-F	43.23 (1.702)	41.23 (1.623)	36.83 (1.450)
68	8812-068-170L□-F	48.31 (1.902)	46.31 (1.823)	41.91 (1.650)
80	8812-080-170L□-F	55.93 (2.202)	53.93 (2.123)	49.53 (1.950)
100	8812-100-170L□-F	68.63 (2.702)	66.63 (2.623)	62.23 (2.450)

8803-□□□-170S□-F (Receptacle, With power contacts)

Unit:mm(inch)

Receptacle (Straight Type)

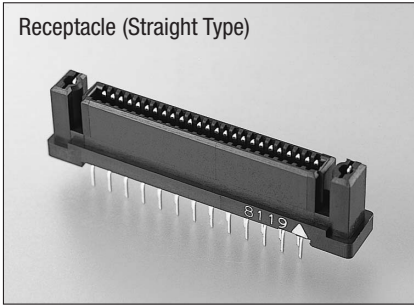
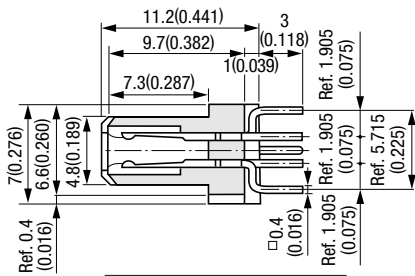
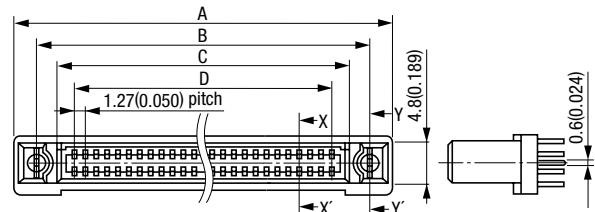
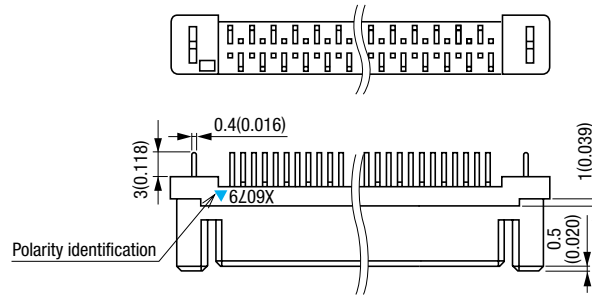
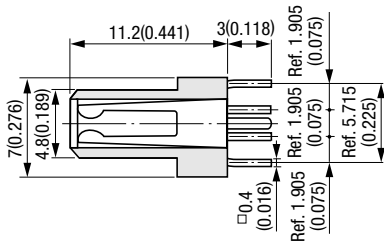
X-X' Cross Section

Y-Y' Cross Section

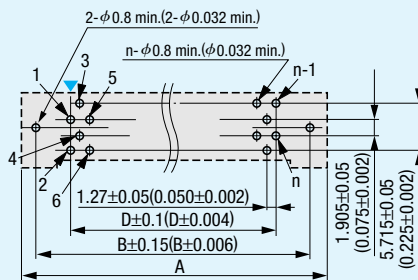
Printed Circuit Board Layout (Component Side View)

For 20,32,40,52,60,68,80,100 contacts

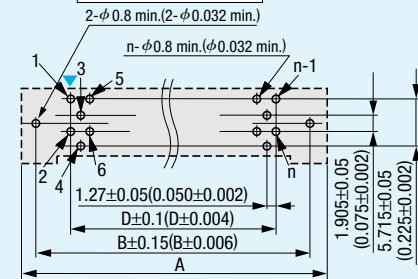

For 26,30,34,50 contacts



▼=Polarity identification

 Recommended PCB Thickness $t=1.6 \pm 0.19 (0.063 \pm 0.007)$

"n" is number of contacts.

Product Table / Dimensions

No. of contacts	Part Number	A	B	C	D
20	8803-020-170S□-F	25.43 (1.001)	20.32 (0.800)	15.43 (0.607)	11.43 (0.450)
26	8803-026-170S□-F	29.24 (1.151)	24.13 (0.950)	19.24 (0.757)	15.24 (0.600)
30	8803-030-170S□-F	31.78 (1.251)	26.67 (1.050)	21.78 (0.857)	17.78 (0.700)
32	8803-032-170S□-F	33.05 (1.301)	27.94 (1.100)	23.05 (0.907)	19.05 (0.750)
34	8803-034-170S□-F	34.32 (1.351)	29.21 (1.150)	24.32 (0.957)	20.32 (0.800)
40	8803-040-170S□-F	38.13 (1.501)	33.02 (1.300)	28.13 (1.107)	24.13 (0.950)
50	8803-050-170S□-F	44.48 (1.751)	39.37 (1.550)	34.48 (1.357)	30.48 (1.200)
52	8803-052-170S□-F	45.75 (1.801)	40.64 (1.593)	35.75 (1.407)	31.75 (1.250)
60	8803-060-170S□-F	50.83 (2.001)	45.72 (1.800)	40.83 (1.607)	36.83 (1.450)
68	8803-068-170S□-F	55.91 (2.201)	50.80 (2.000)	45.91 (1.807)	41.91 (1.650)
80	8803-080-170S□-F	63.53 (2.501)	58.42 (2.300)	53.53 (2.107)	49.53 (1.950)
100	8803-100-170S□-F	76.23 (3.001)	71.12 (2.800)	66.23 (2.607)	62.23 (2.450)

8813-□□□-170S□-F (Plug, With power contacts)

Unit:mm(inch)

Plug (Right Angle Type)

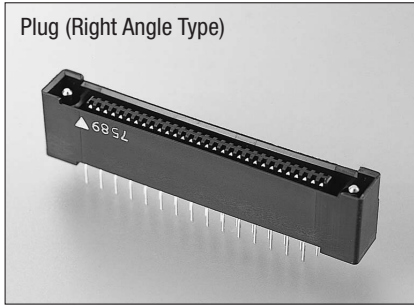

X-X' Cross Section

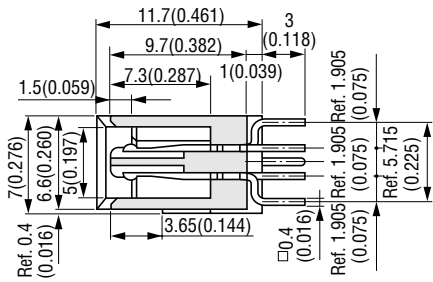

Y-Y' Cross Section

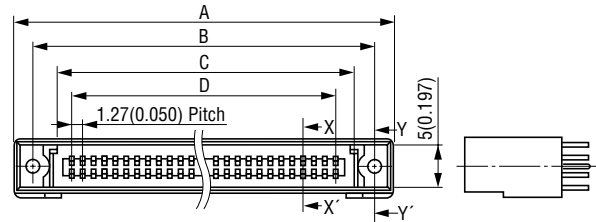
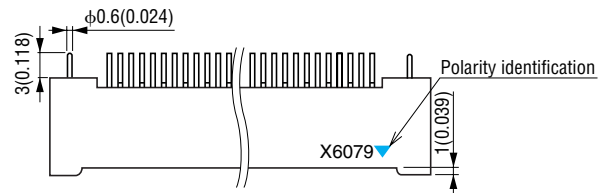
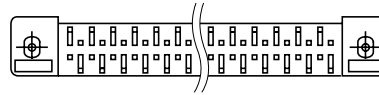
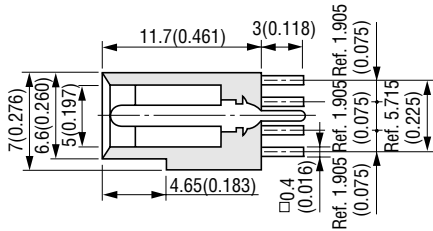

Printed Circuit Board Layout (Component Side View)

For 20,32,40,52,60,68,80,100 contacts

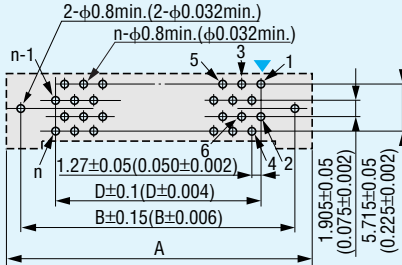

For 26,30,34,50 contacts

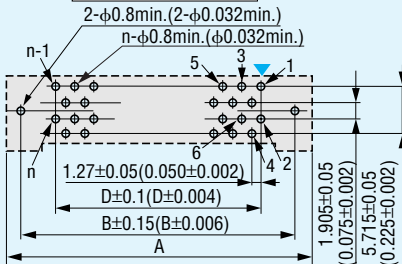

▼=Polarity identification

Recommended PCB Thickness t=1.6±0.19(0.063±0.007)

"n" is number of contacts.

Product Table / Dimensions

No. of contacts	Part Number	A	B	C	D
20	8813-020-170S□-F	25.43 (1.001)	20.32 (0.800)	15.83 (0.623)	11.43 (0.450)
26	8813-026-170S□-F	29.24 (1.151)	24.13 (0.950)	19.64 (0.773)	15.24 (0.600)
30	8813-030-170S□-F	31.78 (1.251)	26.67 (1.050)	22.18 (0.873)	17.78 (0.700)
32	8813-032-170S□-F	33.05 (1.301)	27.94 (1.100)	23.45 (0.923)	19.05 (0.750)
34	8813-034-170S□-F	34.32 (1.351)	29.21 (1.150)	24.72 (0.973)	20.32 (0.800)
40	8813-040-170S□-F	38.13 (1.501)	33.02 (1.300)	28.53 (1.123)	24.13 (0.950)
50	8813-050-170S□-F	44.48 (1.751)	39.37 (1.550)	34.88 (1.373)	30.48 (1.200)
52	8813-052-170S□-F	45.75 (1.801)	40.64 (1.593)	36.15 (1.423)	31.75 (1.250)
60	8813-060-170S□-F	50.83 (2.001)	45.72 (1.800)	41.23 (1.623)	36.83 (1.450)
68	8813-068-170S□-F	55.91 (2.201)	50.80 (2.000)	46.31 (1.823)	41.91 (1.650)
80	8813-080-170S□-F	63.53 (2.501)	58.42 (2.300)	53.93 (2.123)	49.53 (1.950)
100	8813-100-170S□-F	76.23 (3.001)	71.12 (2.800)	66.63 (2.623)	62.23 (2.450)

8803-□□□-170L□-F (Receptacle, With power contacts)

Unit:mm(inch)

Receptacle (Right Angle Type)

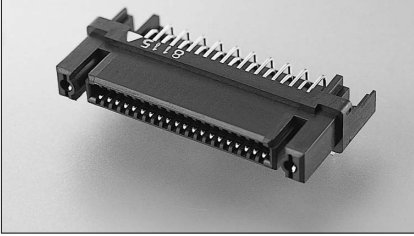
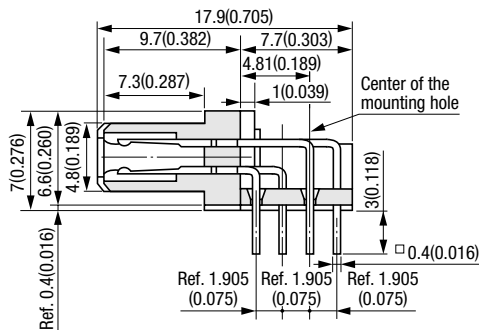
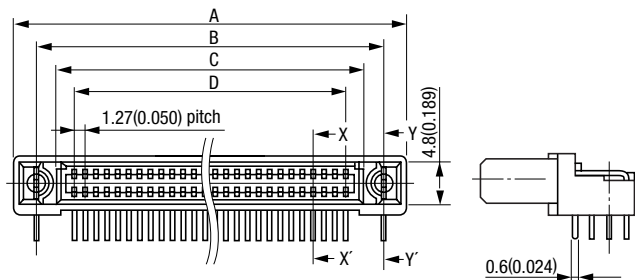
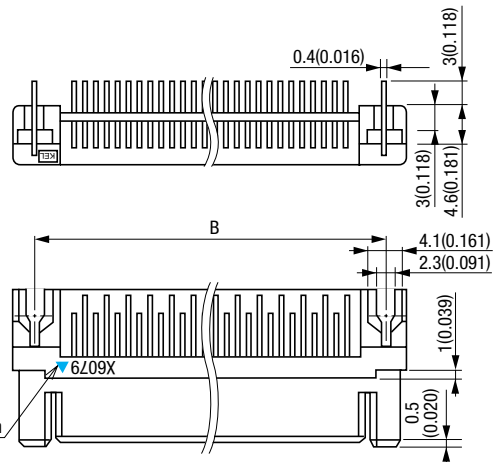
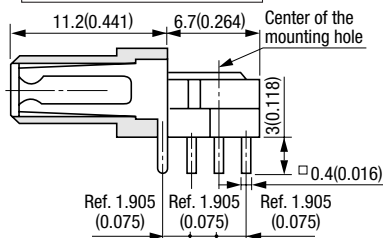
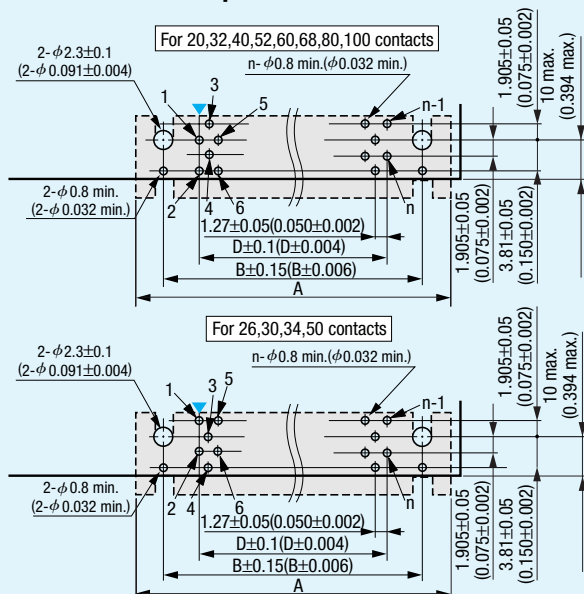
X-X' Cross Section

Y-Y' Cross Section

Printed Circuit Board Layout (Component Side View)

▼=Polarity identification

 Recommended PCB Thickness $t=1.6\pm0.19(0.063\pm0.007)$

"n" is number of contacts.

Product Table / Dimensions

No. of contacts	Part Number	A	B	C	D
20	8803-020-170L□-F	25.43 (1.001)	20.32 (0.800)	15.43 (0.607)	11.43 (0.450)
26	8803-026-170L□-F	29.24 (1.151)	24.13 (0.950)	19.24 (0.757)	15.24 (0.600)
30	8803-030-170L□-F	31.78 (1.251)	26.67 (1.050)	21.78 (0.857)	17.78 (0.700)
32	8803-032-170L□-F	33.05 (1.301)	27.94 (1.100)	23.05 (0.907)	19.05 (0.750)
34	8803-034-170L□-F	34.32 (1.351)	29.21 (1.150)	24.32 (0.957)	20.32 (0.800)
40	8803-040-170L□-F	38.13 (1.501)	33.02 (1.300)	28.13 (1.107)	24.13 (0.950)
50	8803-050-170L□-F	44.48 (1.751)	39.37 (1.550)	34.48 (1.357)	30.48 (1.200)
52	8803-052-170L□-F	45.75 (1.801)	40.64 (1.593)	35.75 (1.407)	31.75 (1.250)
60	8803-060-170L□-F	50.83 (2.001)	45.72 (1.800)	40.83 (1.607)	36.83 (1.450)
68	8803-068-170L□-F	55.91 (2.201)	50.80 (2.000)	45.91 (1.807)	41.91 (1.650)
80	8803-080-170L□-F	63.53 (2.501)	58.42 (2.300)	53.53 (2.107)	49.53 (1.950)
100	8803-100-170L□-F	76.23 (3.001)	71.12 (2.800)	66.23 (2.607)	62.23 (2.450)

8813-□□□-170L□-F (Plug, With power contacts)

Unit:mm(inch)

Plug (Right Angle Type)

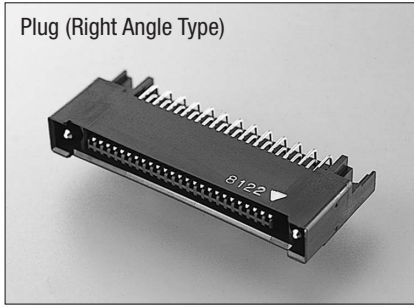

X-X' Cross Section

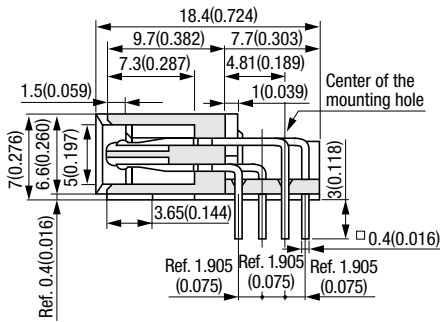

Y-Y' Cross Section

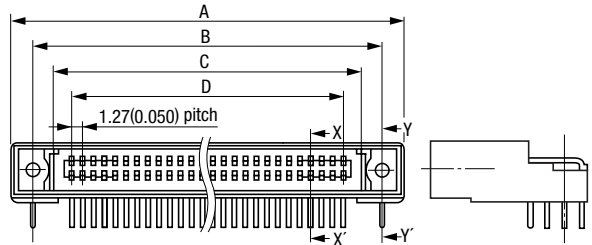
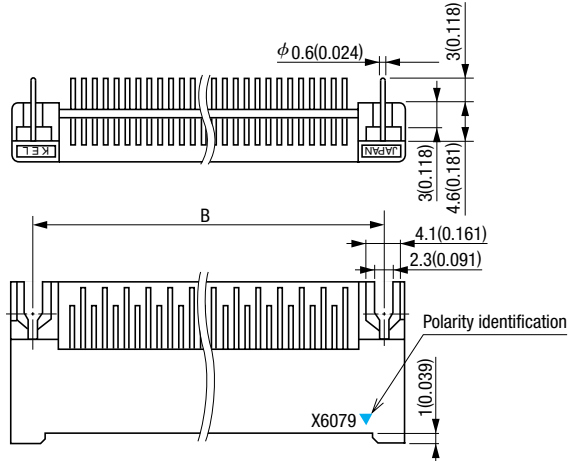
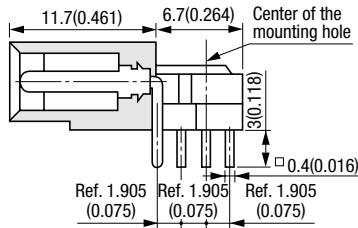

Printed Circuit Board Layout (Component Side View)

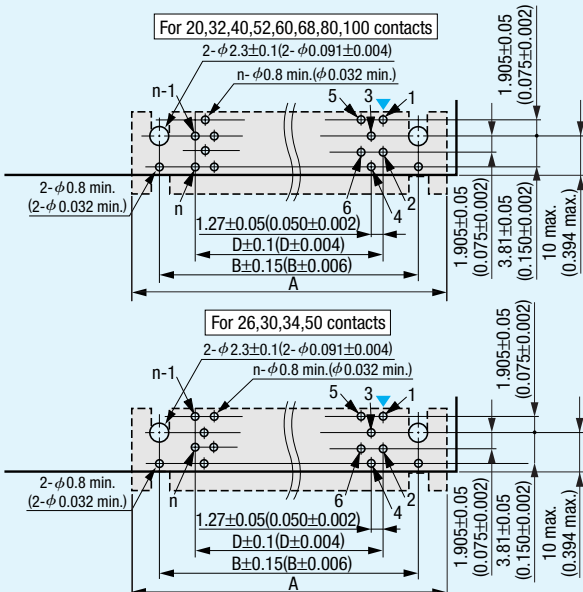

▼=Polarity identification
Recommended PCB Thickness t=1.6±0.19(0.063±0.007)
"n" is number of contacts.

Product Table / Dimensions

No. of contacts	Part Number	A	B	C	D
20	8813-020-170L□-F	25.43 (1.001)	20.32 (0.800)	15.83 (0.623)	11.43 (0.450)
26	8813-026-170L□-F	29.24 (1.151)	24.13 (0.950)	19.64 (0.773)	15.24 (0.600)
30	8813-030-170L□-F	31.78 (1.251)	26.67 (1.050)	22.18 (0.873)	17.78 (0.700)
32	8813-032-170L□-F	33.05 (1.301)	27.94 (1.100)	23.45 (0.923)	19.05 (0.750)
34	8813-034-170L□-F	34.32 (1.351)	29.21 (1.150)	24.72 (0.973)	20.32 (0.800)
40	8813-040-170L□-F	38.13 (1.501)	33.02 (1.300)	28.53 (1.123)	24.13 (0.950)
50	8813-050-170L□-F	44.48 (1.751)	39.37 (1.550)	34.88 (1.373)	30.48 (1.200)
52	8813-052-170L□-F	45.75 (1.801)	40.64 (1.593)	36.15 (1.423)	31.75 (1.250)
60	8813-060-170L□-F	50.83 (2.001)	45.72 (1.800)	41.23 (1.623)	36.83 (1.450)
68	8813-068-170L□-F	55.91 (2.201)	50.80 (2.000)	46.31 (1.823)	41.91 (1.650)
80	8813-080-170L□-F	63.53 (2.501)	58.42 (2.300)	53.93 (2.123)	49.53 (1.950)
100	8813-100-170L□-F	76.23 (3.001)	71.12 (2.800)	66.63 (2.623)	62.23 (2.450)

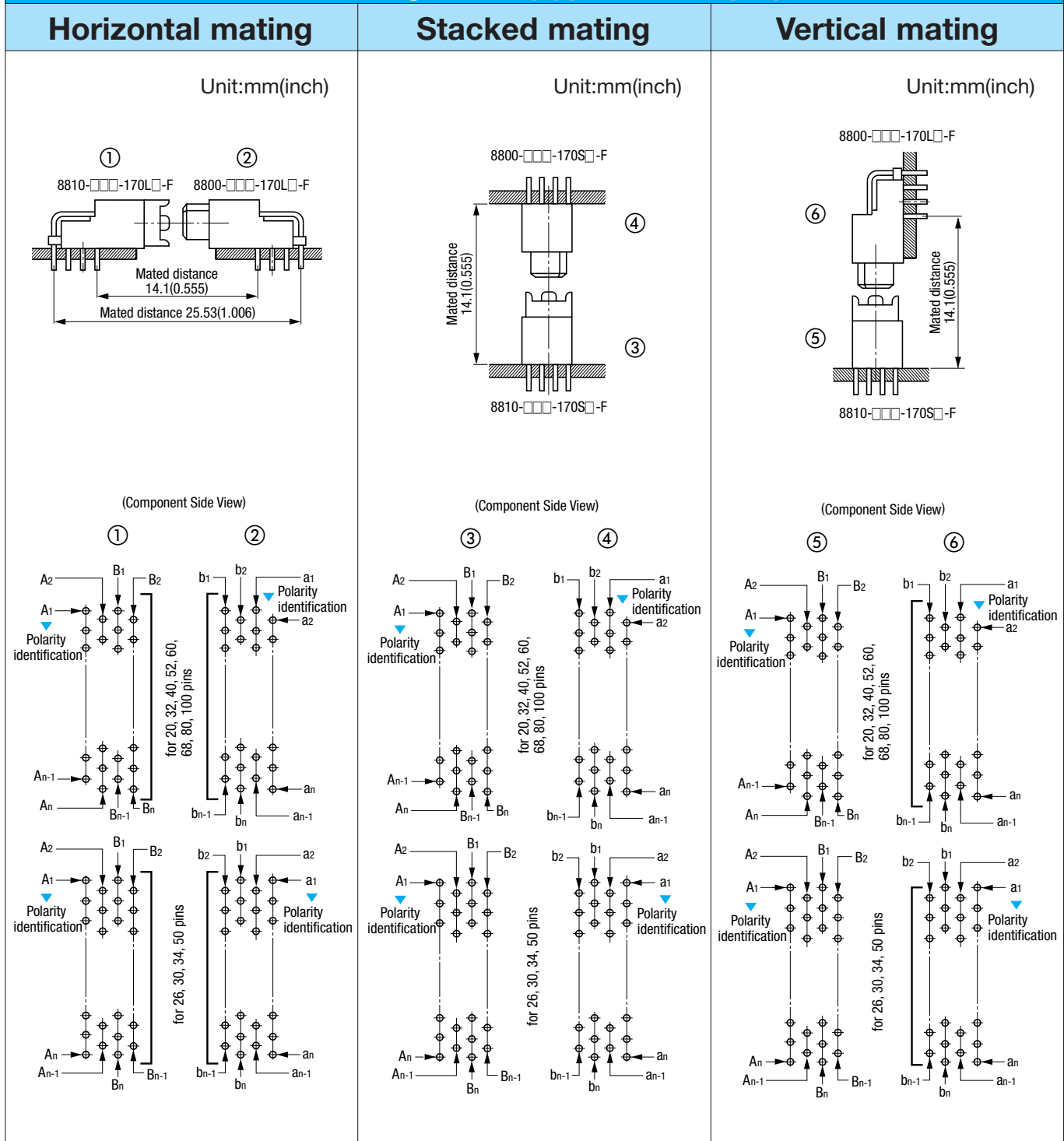
Pin Assignment (Typical example)

Specifications and dimensions are subject to change without notice